

ORGANIGRAMME DES SERVICES MUNICIPAUX



AVRIL 2008

SOMMAIRE

Municipalité	
Organigramme général des services	page 02
PRESENTATION DES SERVICES	
Direction générale des services	page 03
Direction des ressources humaines	page 04
Service Juridique - assurances	page 05
Direction des finances	page 06
Service Commande publique	page 07
Service Education, Péri et extra scolaire	page 08
Annexe : service Péri et extra scolaire	page 09
Service Population	page 10
Service Prévention et Sécurité	page 11
Police municipale	page 12
Services techniques	page 13
Annexe : Service Jardins	page 14
Service Voirie	page 15
Service Foncier-urbanisme	page 16
Service Informatique et téléphonie	page 17
Service Communication - documentation	page 18
Service Nettoyage des locaux	page 19
Jeunesse – sport – culture - vie associative	page 20
Bibliothèque	page 21
Organismes partenaires	page 22
• Ecole de musique et de danse	page 22
• Office Socio Culturel	
• Centre médico psychologique infantile	page 22
CCAS	page 23
Maison de la petite enfance	page 24
Annexe : Assistantes maternelles	page 25

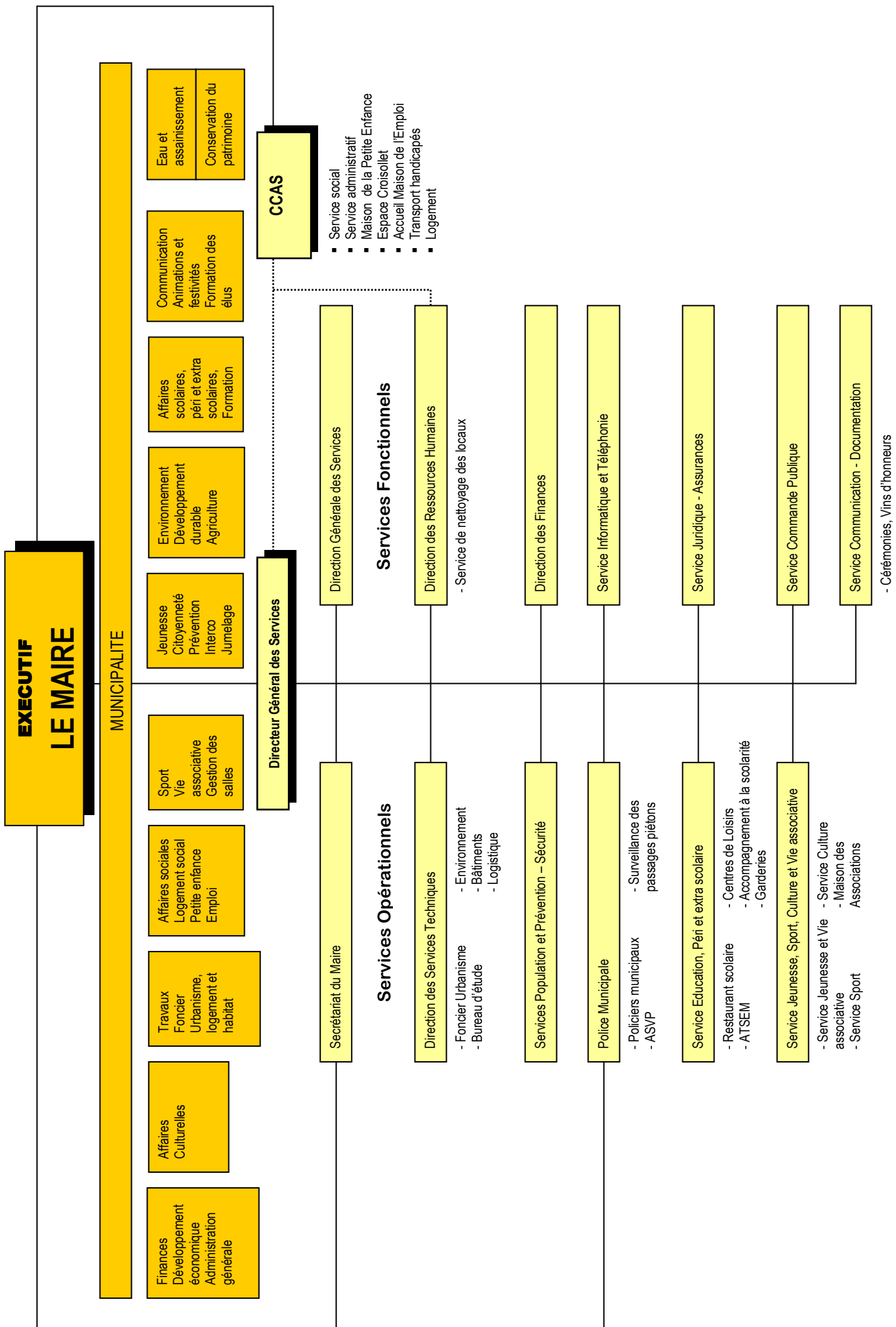

DIRECTION GENERALE DES SERVICES

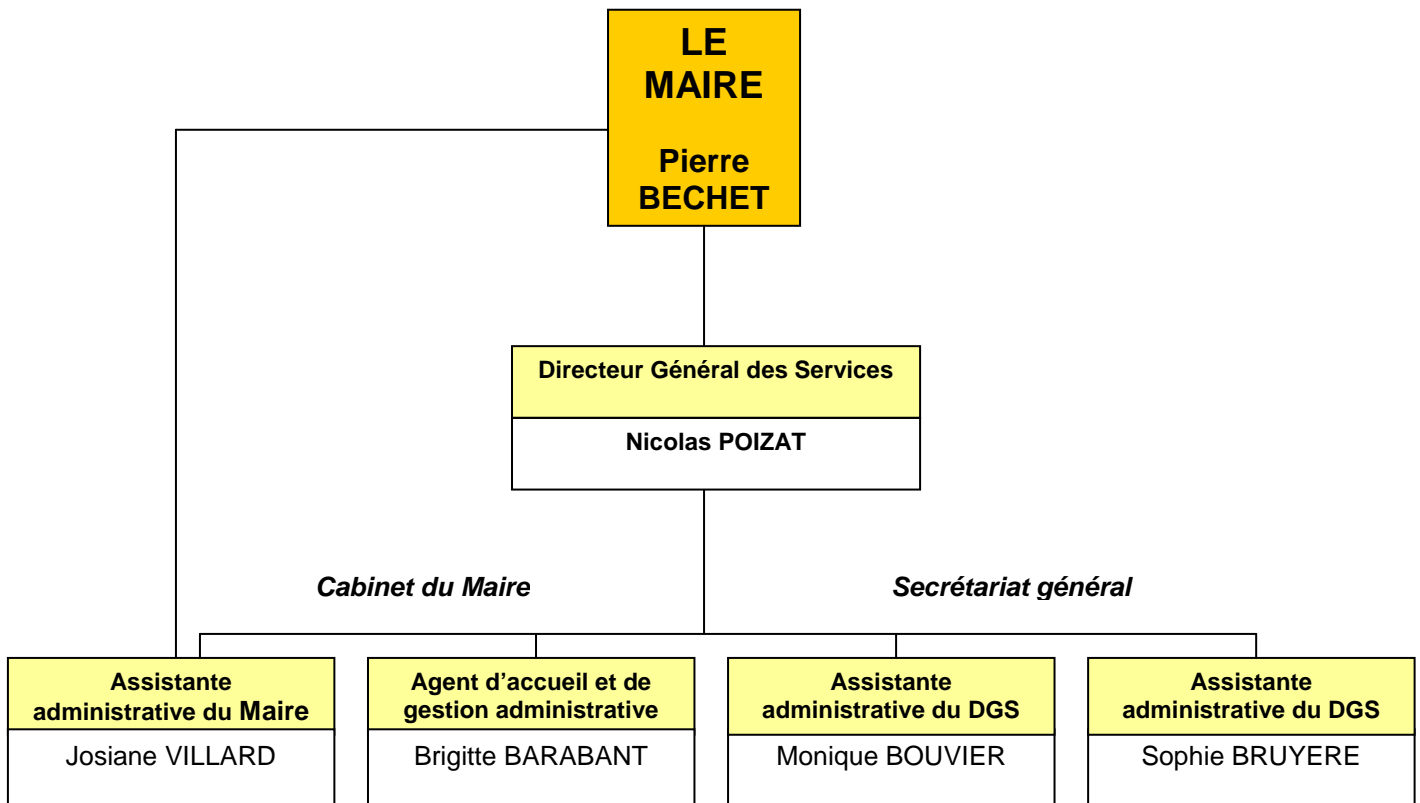

DIRECTION DES RESSOURCES HUMAINES

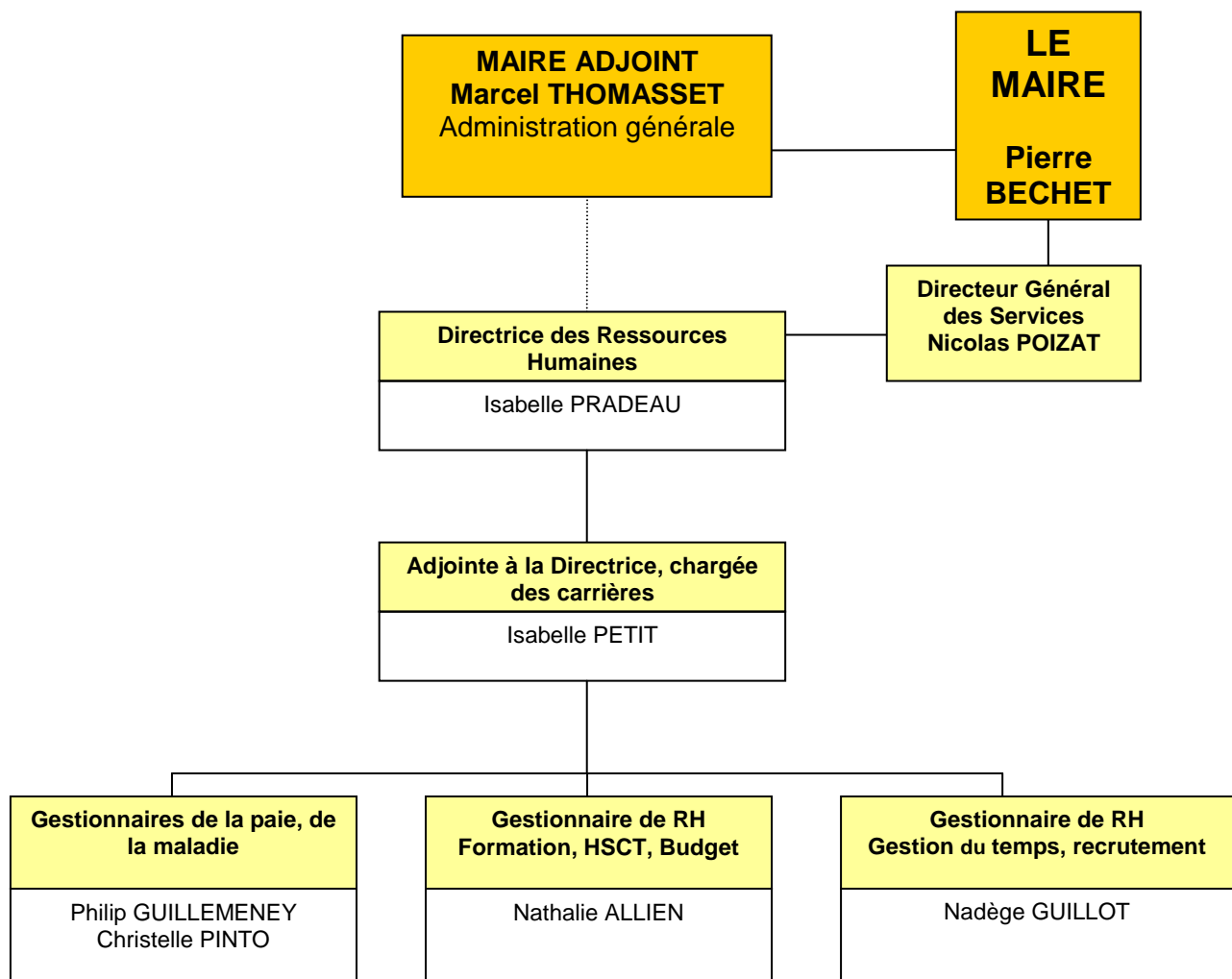

SERVICE JURIDIQUE - ASSURANCES

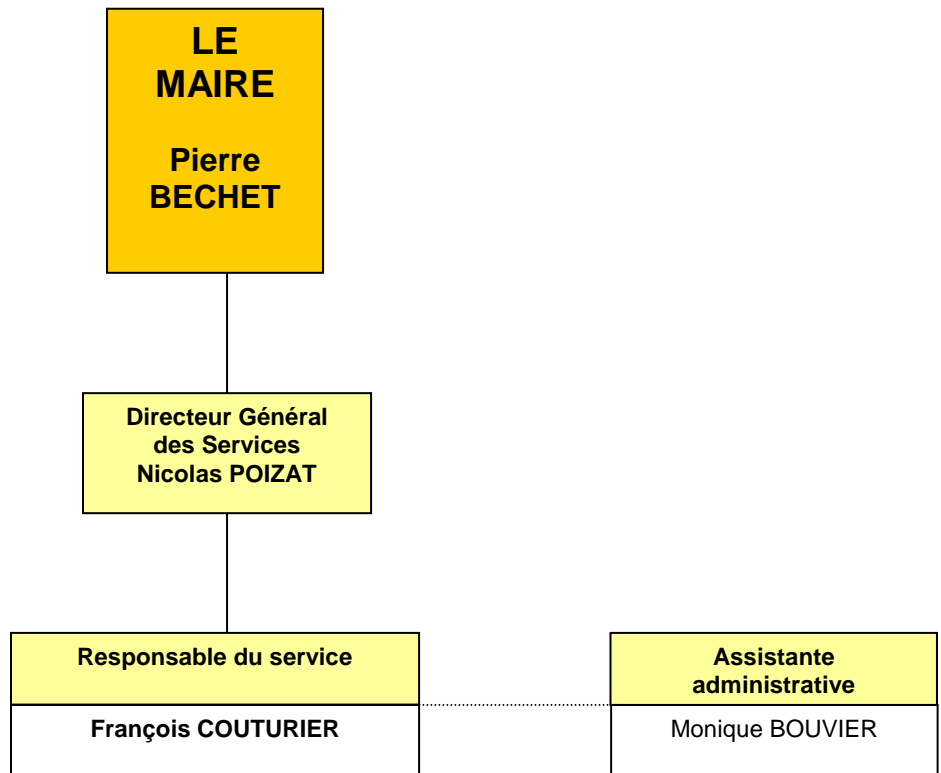

DIRECTION DES FINANCES

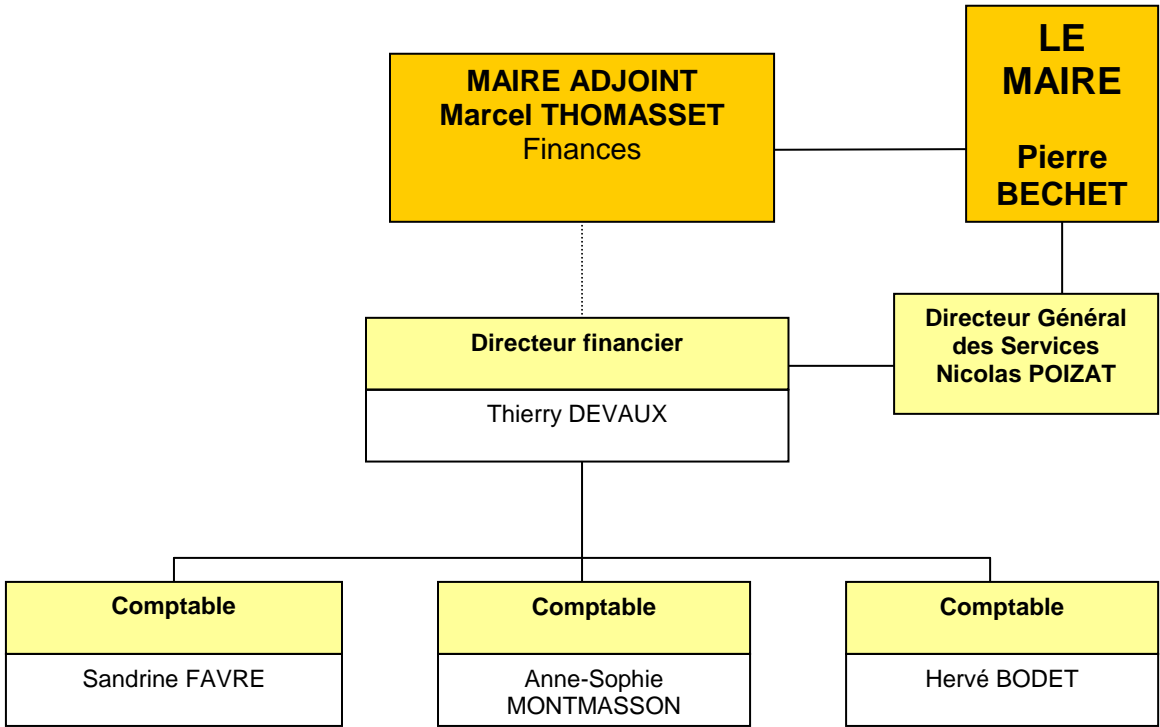

SERVICE COMMANDE PUBLIQUE

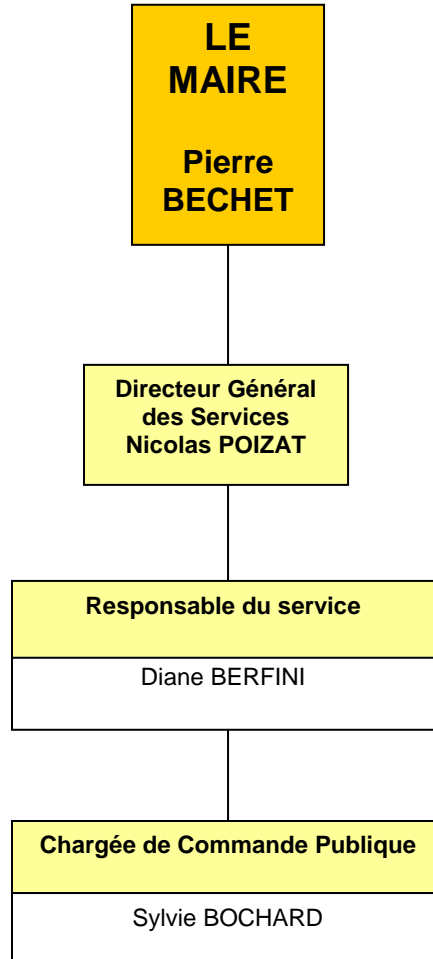

SERVICE EDUCATION PERI ET EXTRA SCOLAIRE

LE MAIRE
Pierre BECHET

MAIRE ADJOINT
Suzanne CERONI
Affaires scolaires, péri et extra scolaires

Directeur Général des Services
Nicolas POIZAT

Responsable du service
Emmanuel CATHÉLIN

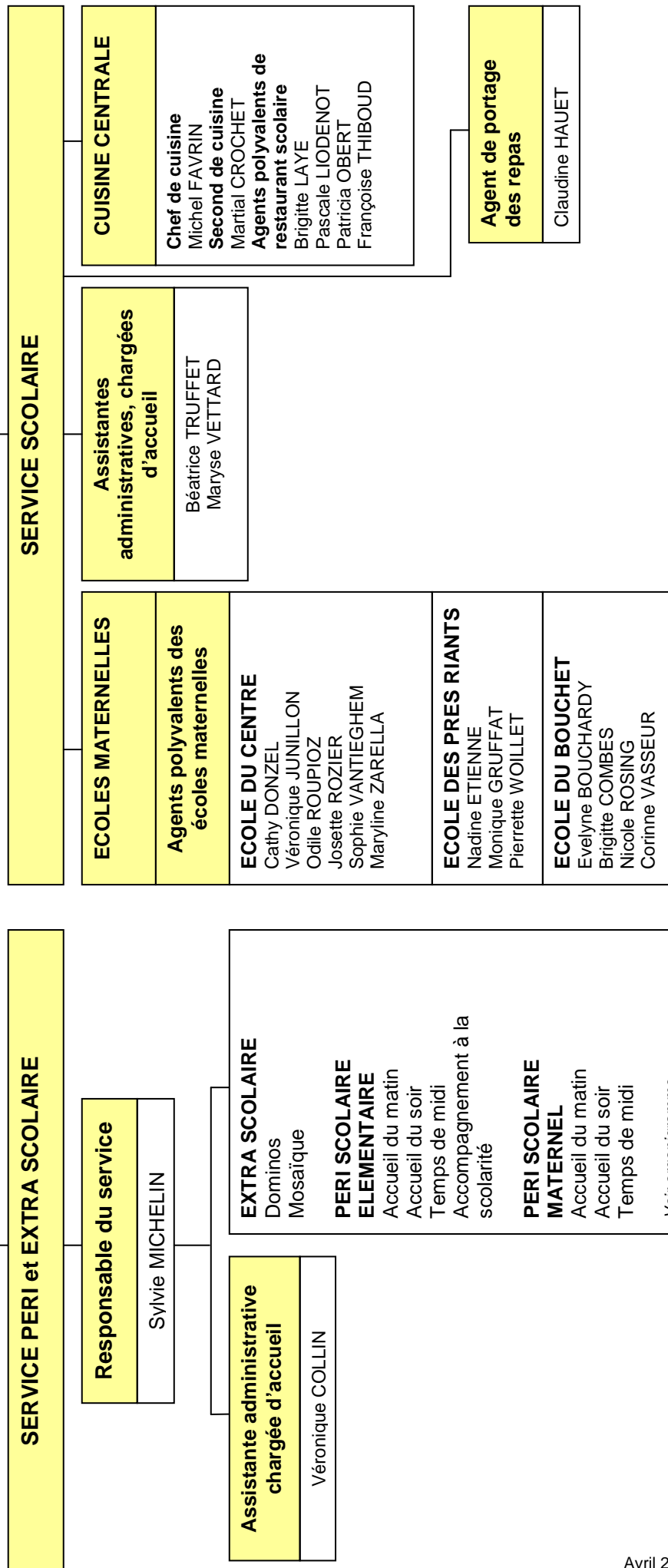

SERVICE PERI ET EXTRA SCOLAIRE

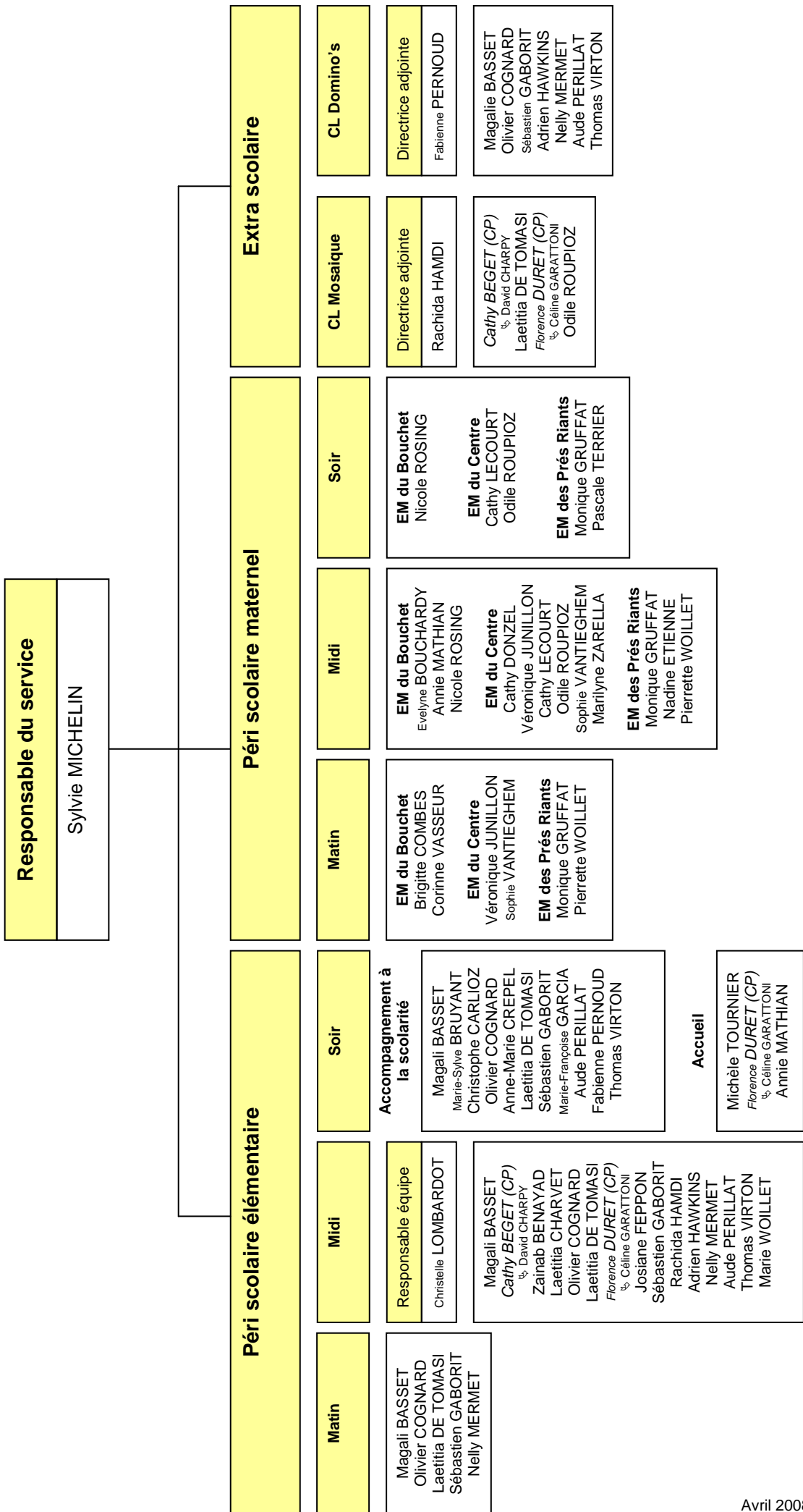

SERVICE POPULATION

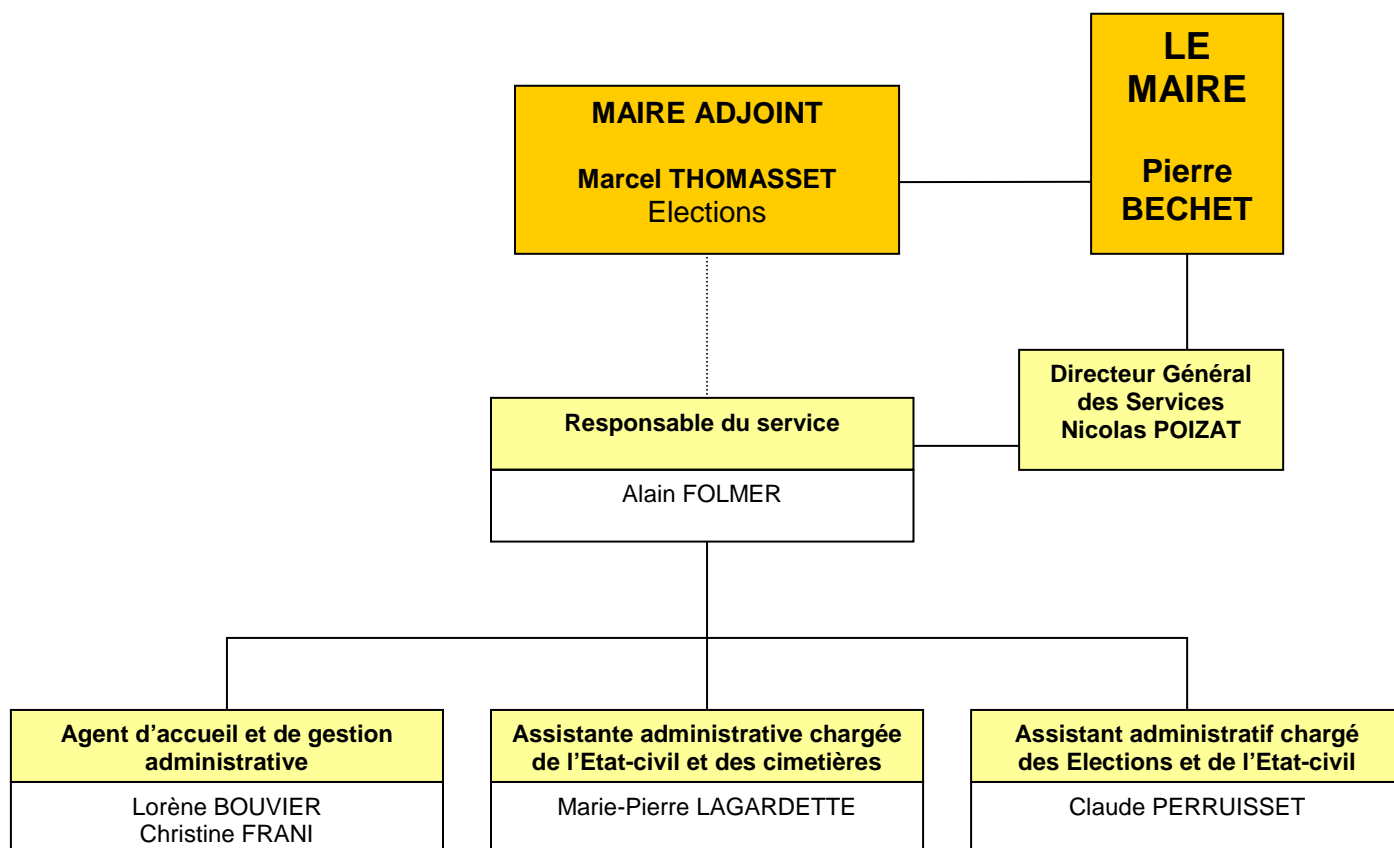

SERVICE PREVENTION ET SECURITE

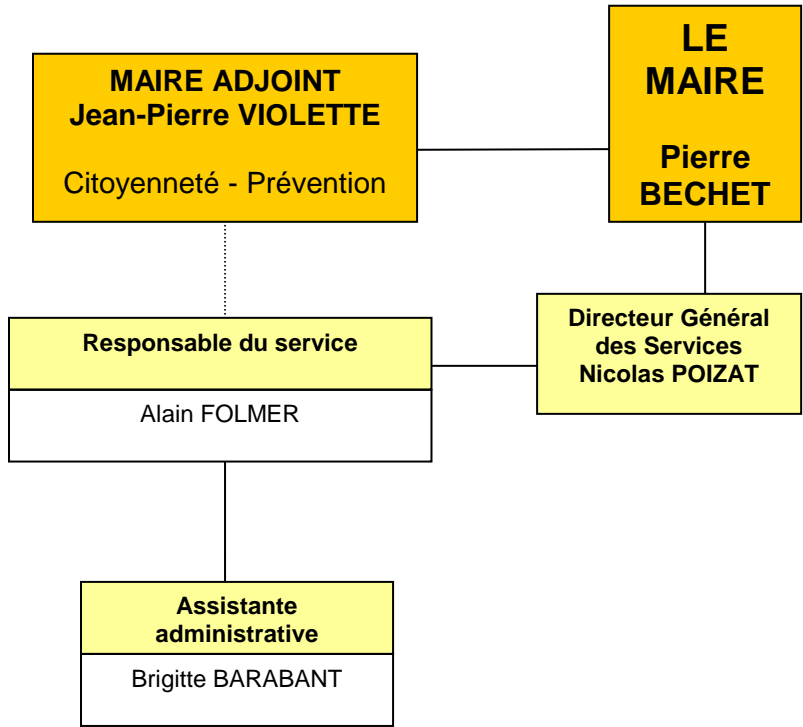

POLICE MUNICIPALE

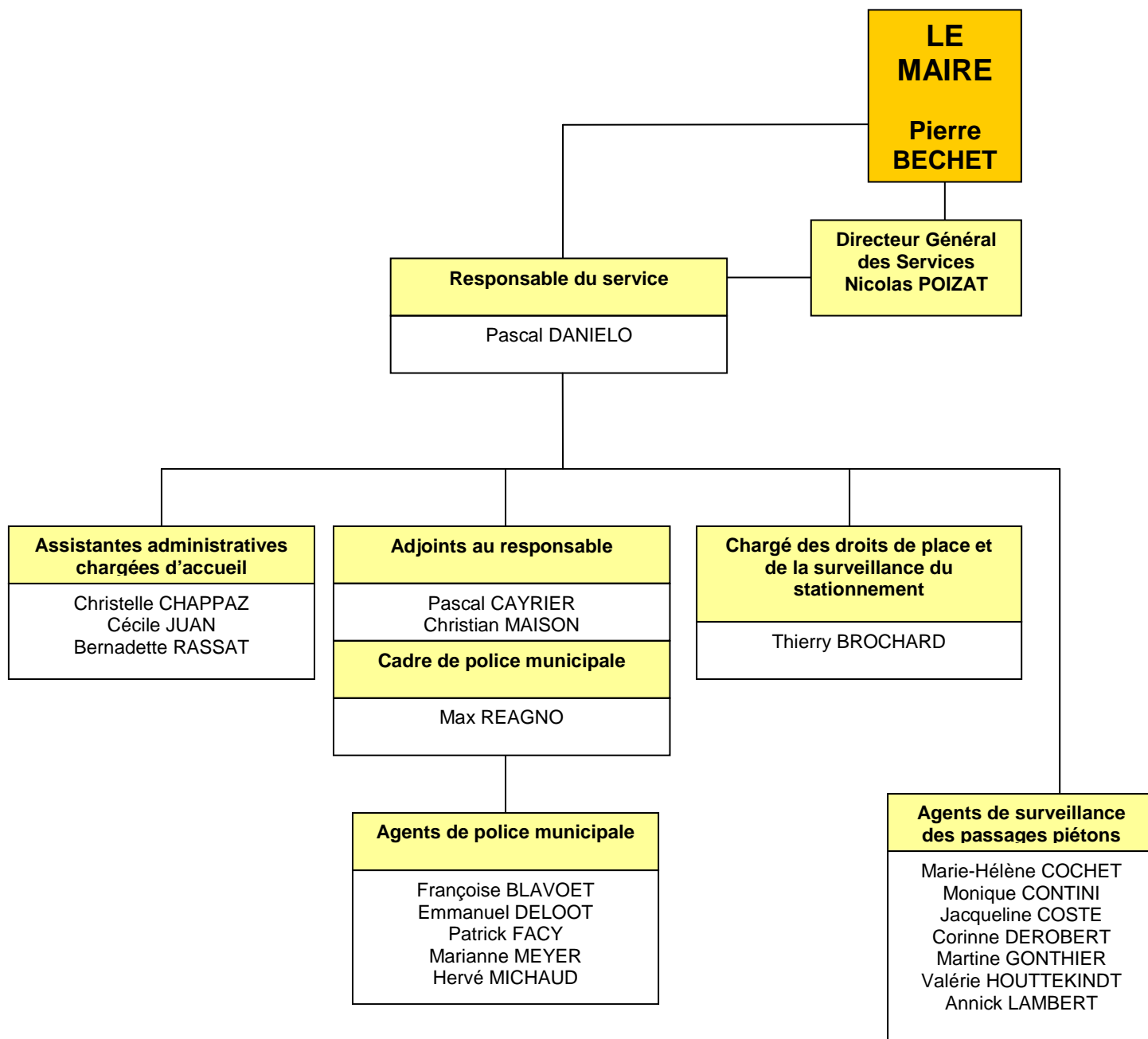

SERVICES TECHNIQUES

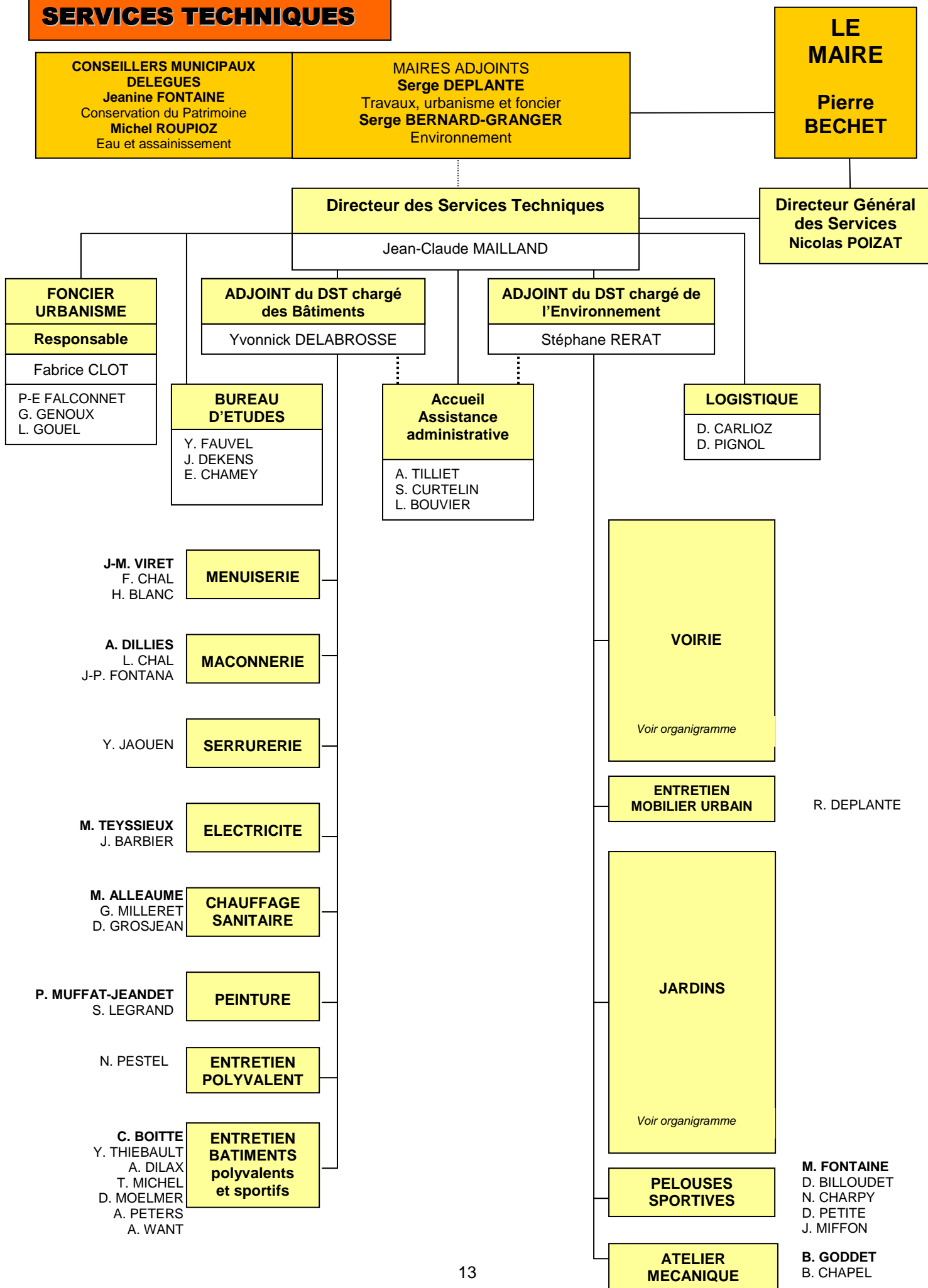

SERVICE JARDINS

Cf. organigramme des Services techniques.

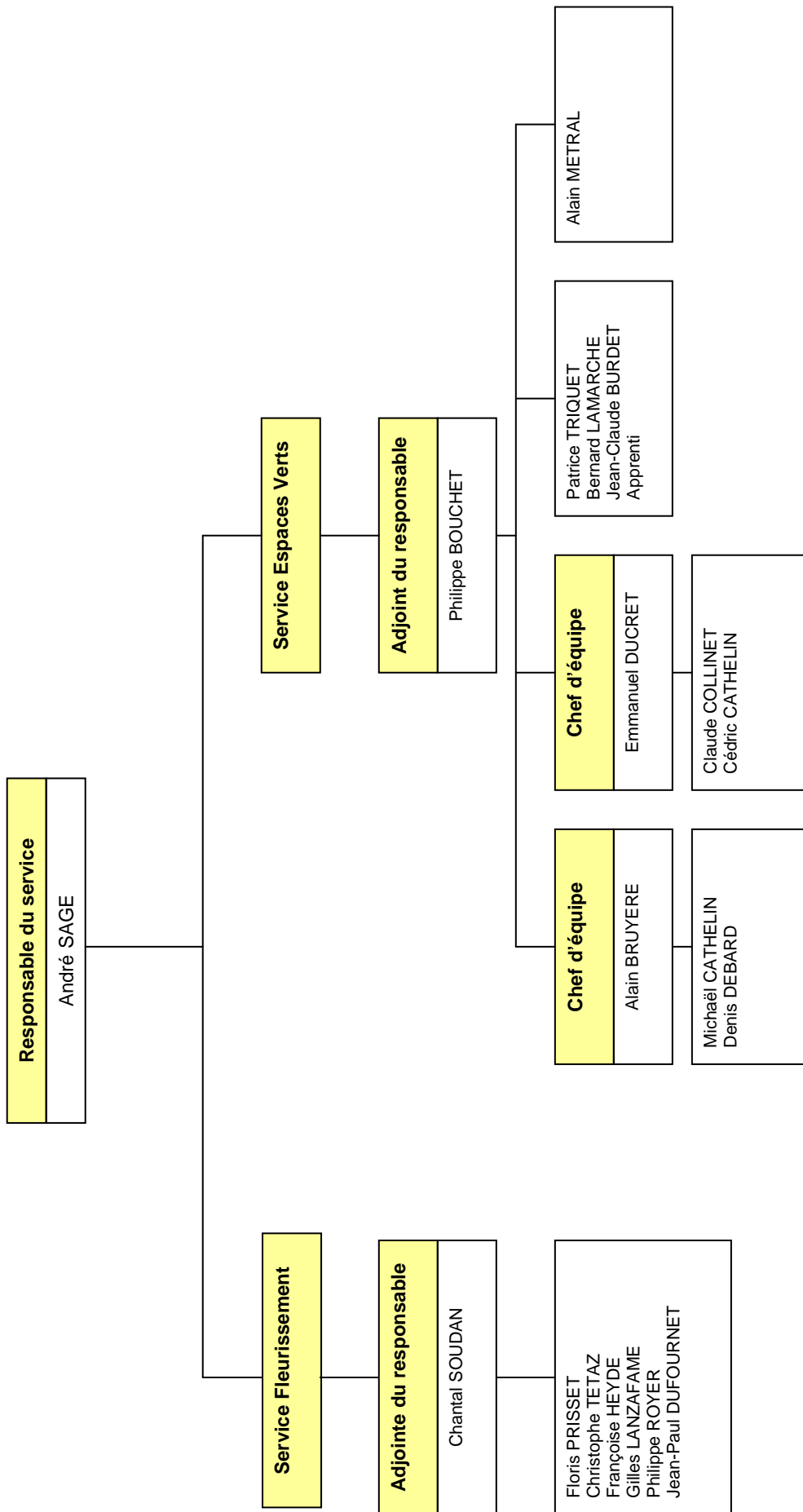

SERVICE VOIRIE

Cf. organigramme des Services techniques

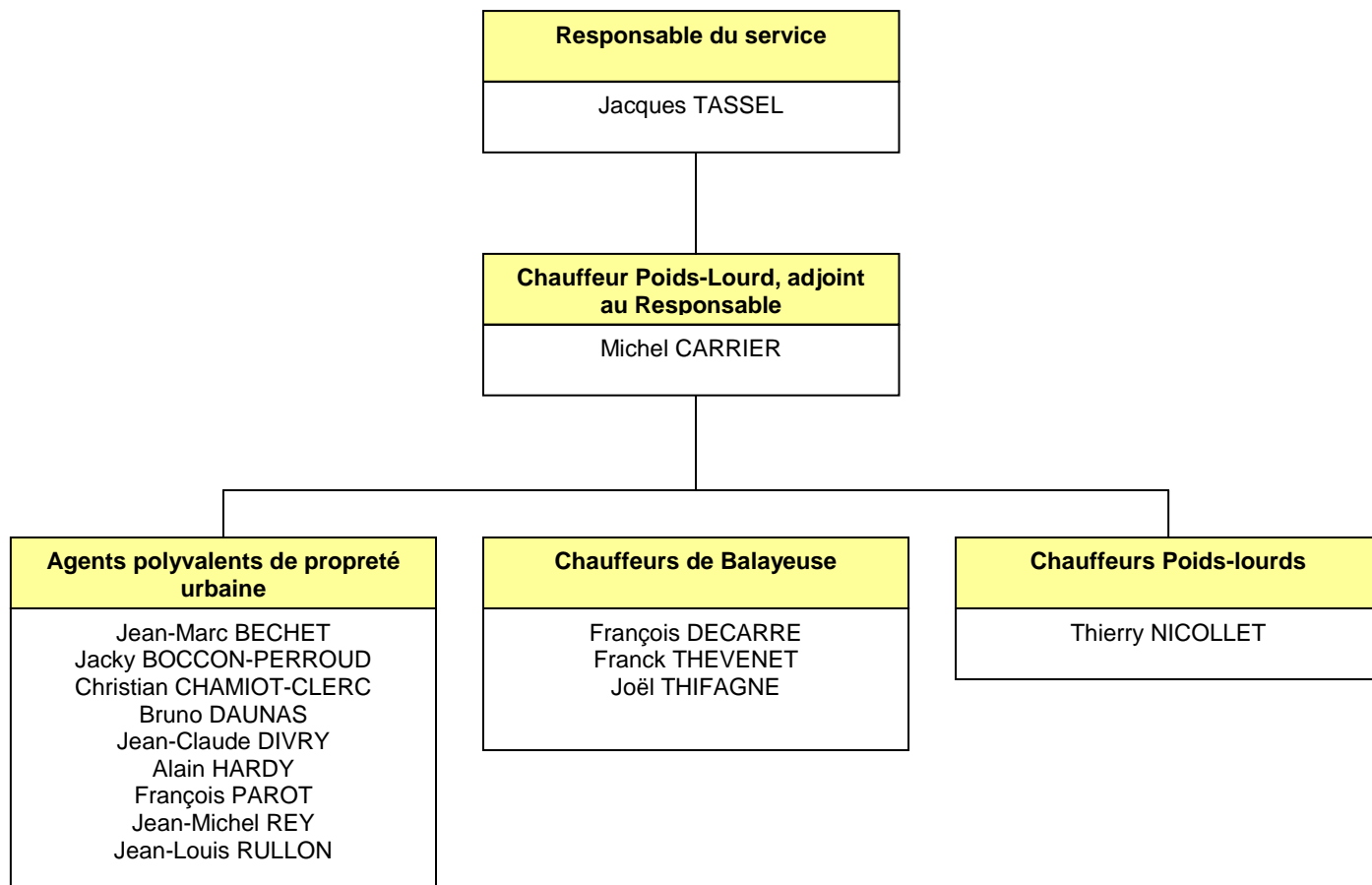

SERVICE FONCIER URBANISME

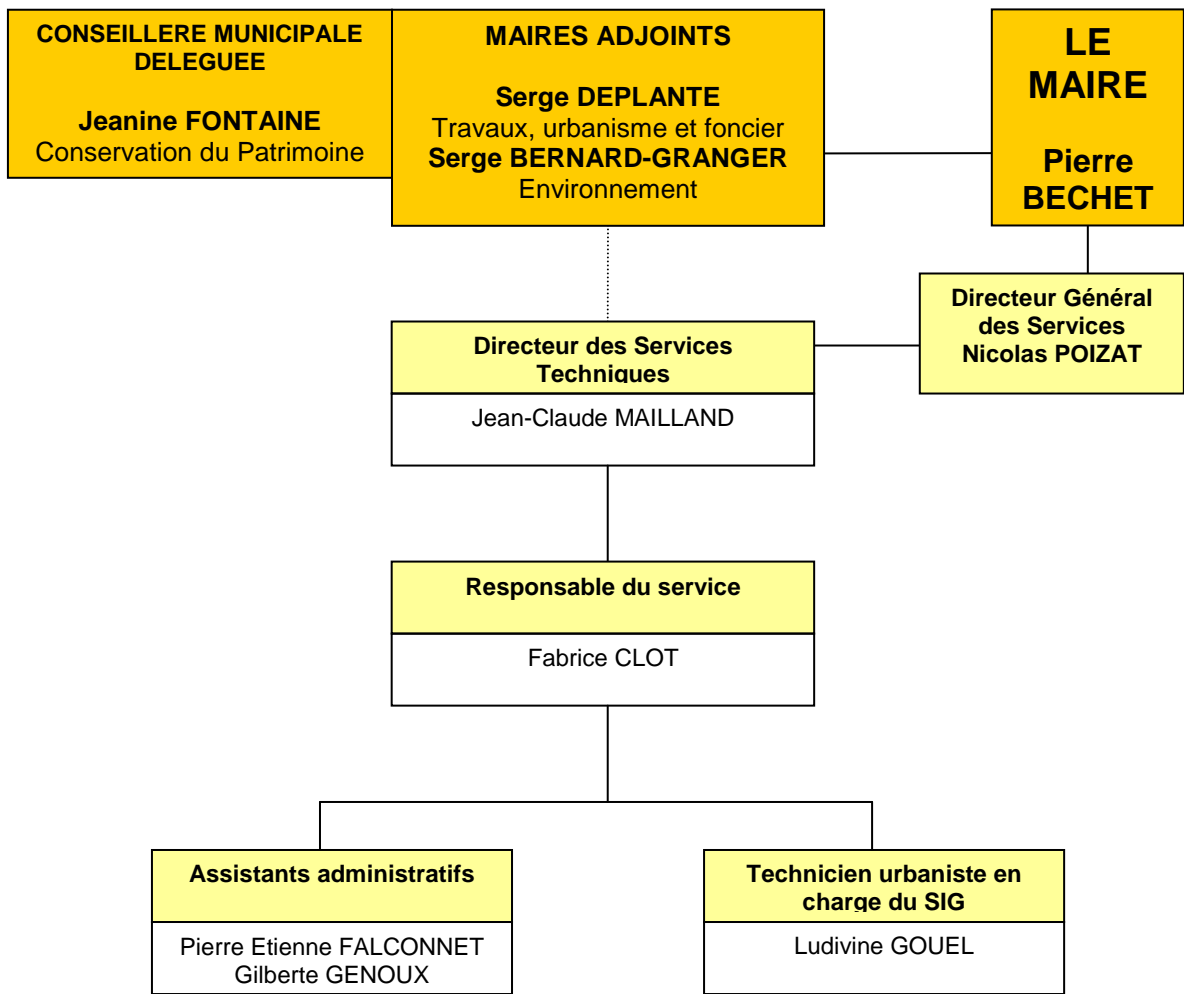

SERVICE INFORMATIQUE ET TELEPHONIE

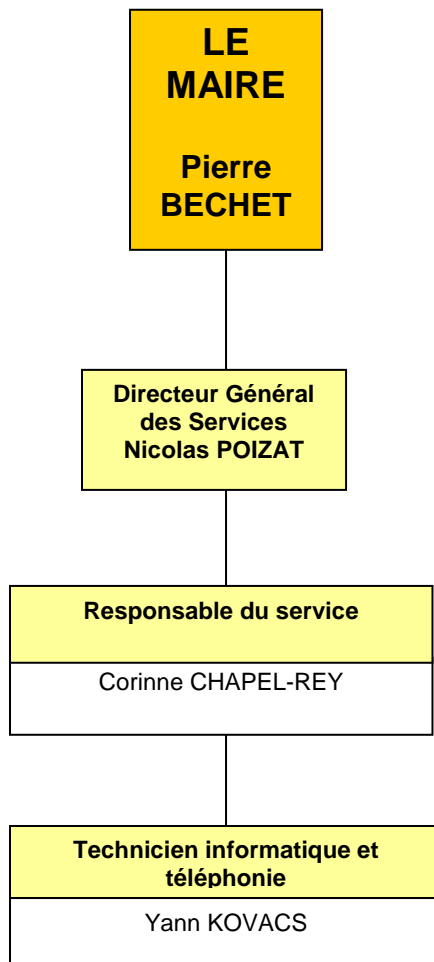

SERVICE COMMUNICATION DOCUMENTATION

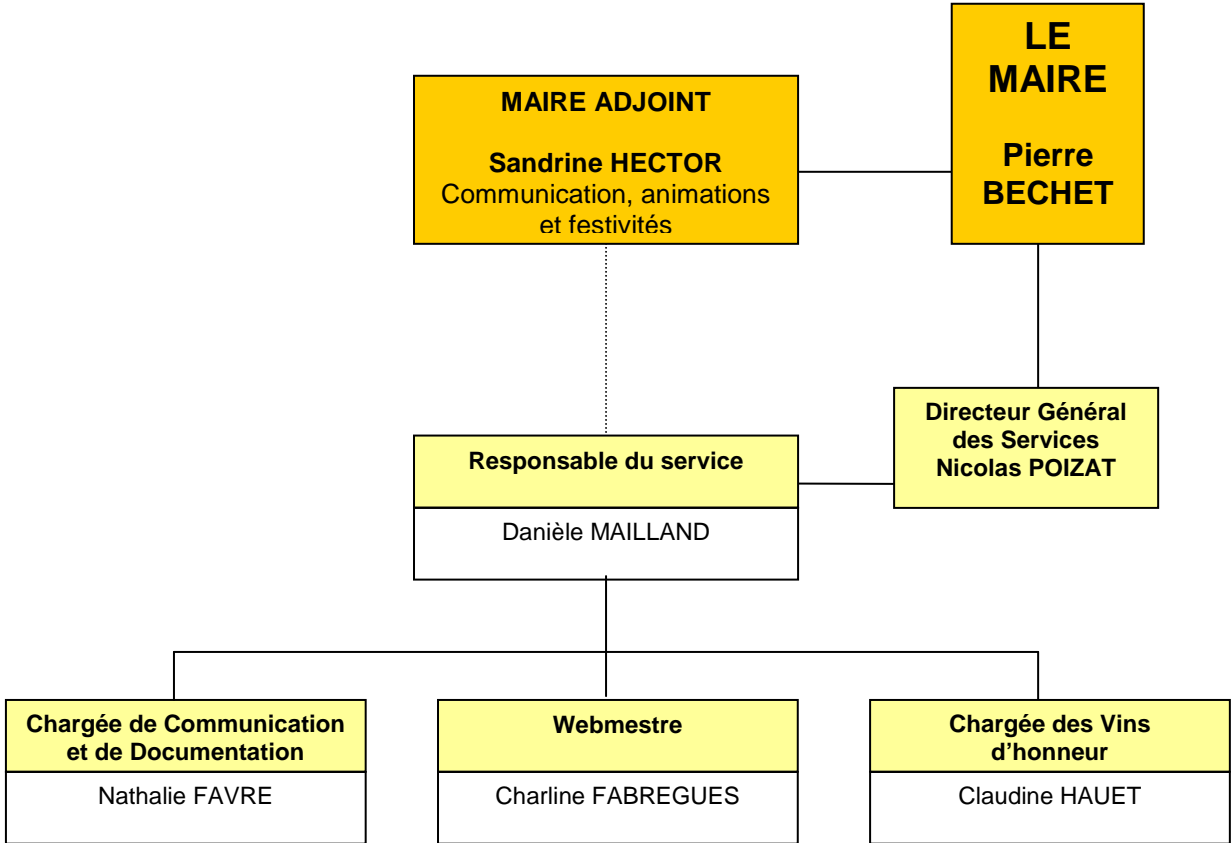

SERVICE DE NETTOYAGE DES LOCAUX

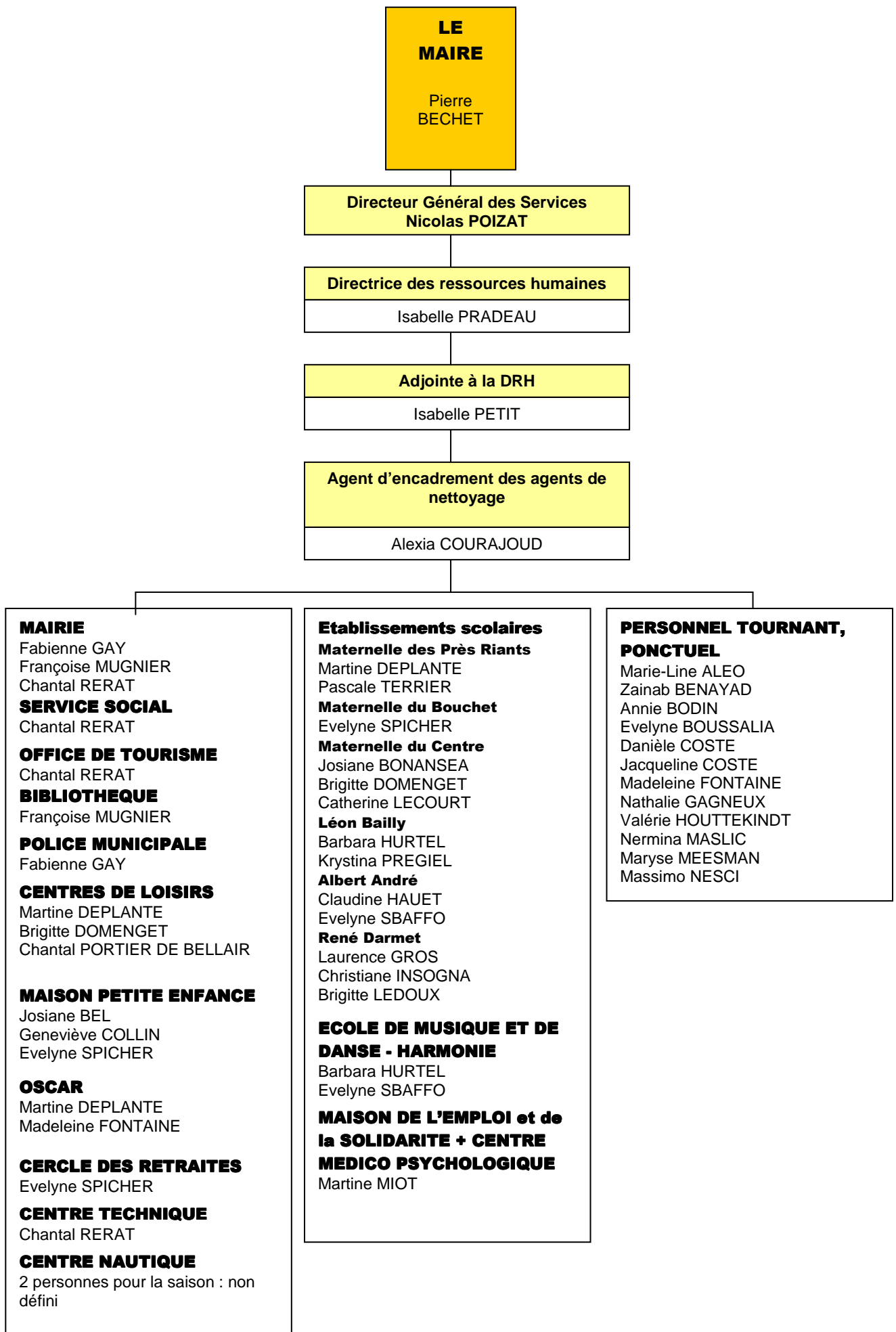

SERVICE JEUNESSE - SPORT CULTURE – VIE ASSOCIATIVE

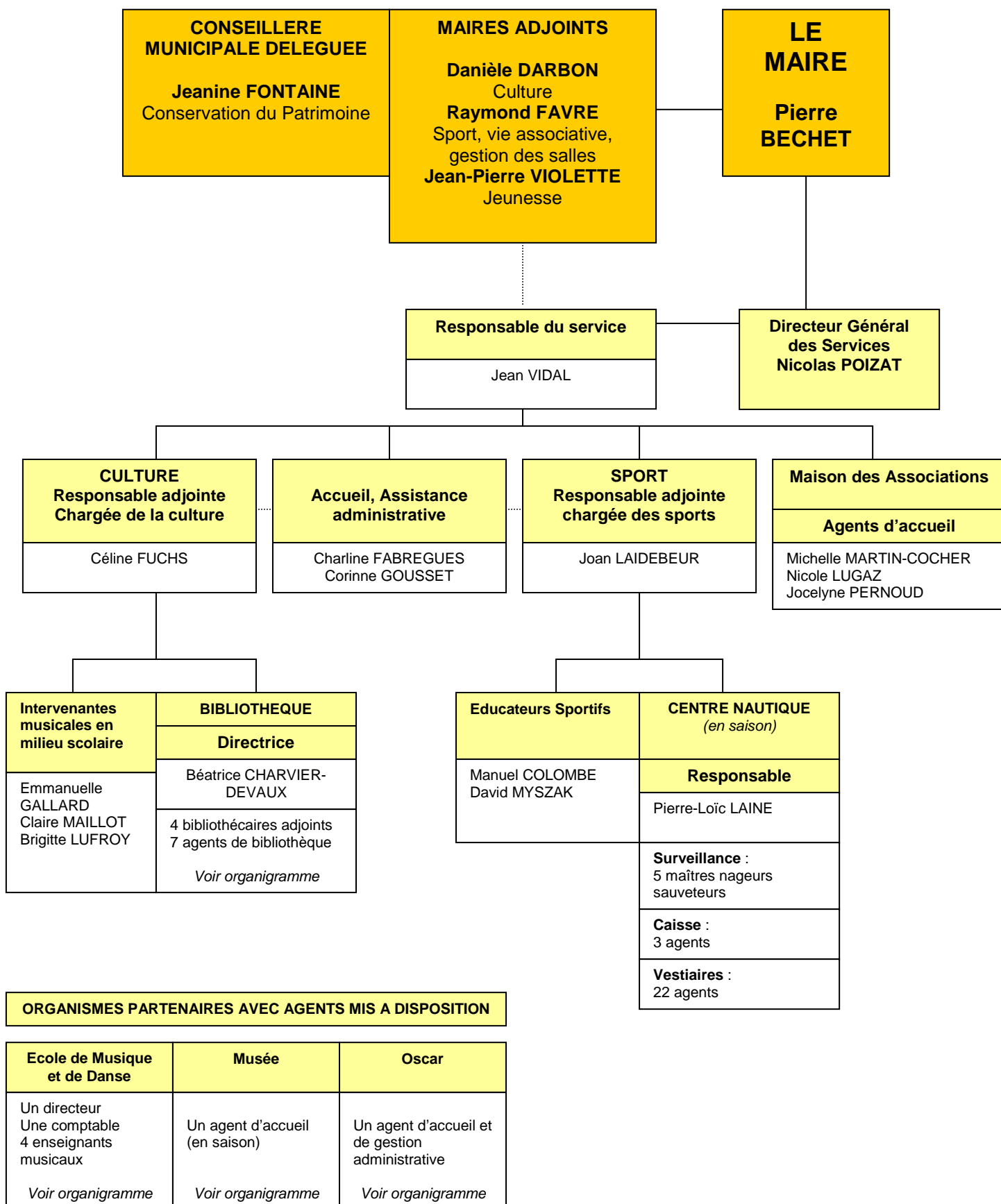

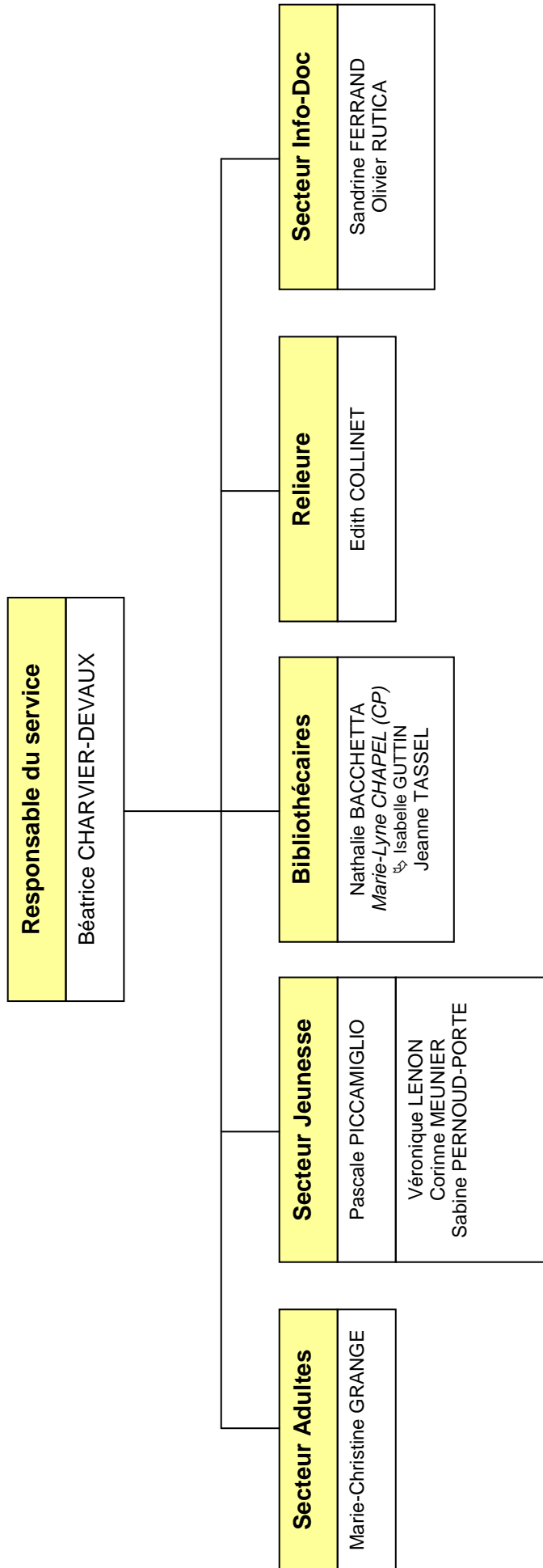

ORGANISMES PARTENAIRES

Personnel mis à disposition auprès d'organismes partenaires.

Ecole de Musique et de Danse

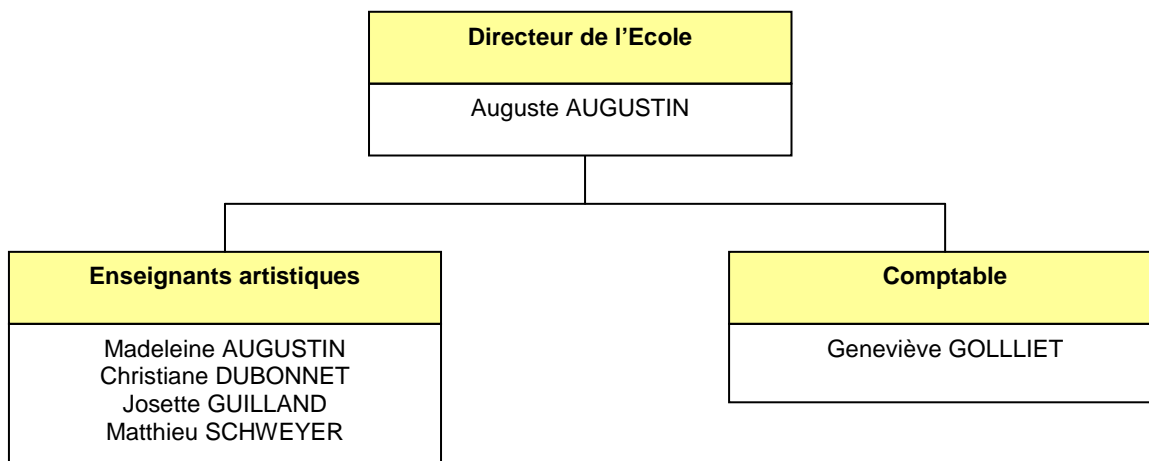

Office Socio Culturel de l'Albanais et de Rumilly

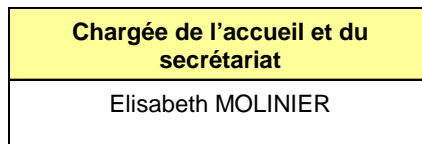

Musée de l'Albanais

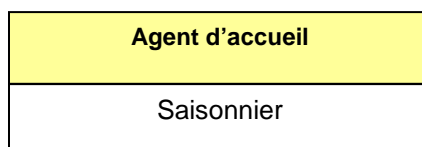

CMPI

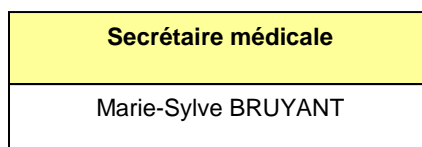

CENTRE COMMUNAL D'ACTION SOCIALE

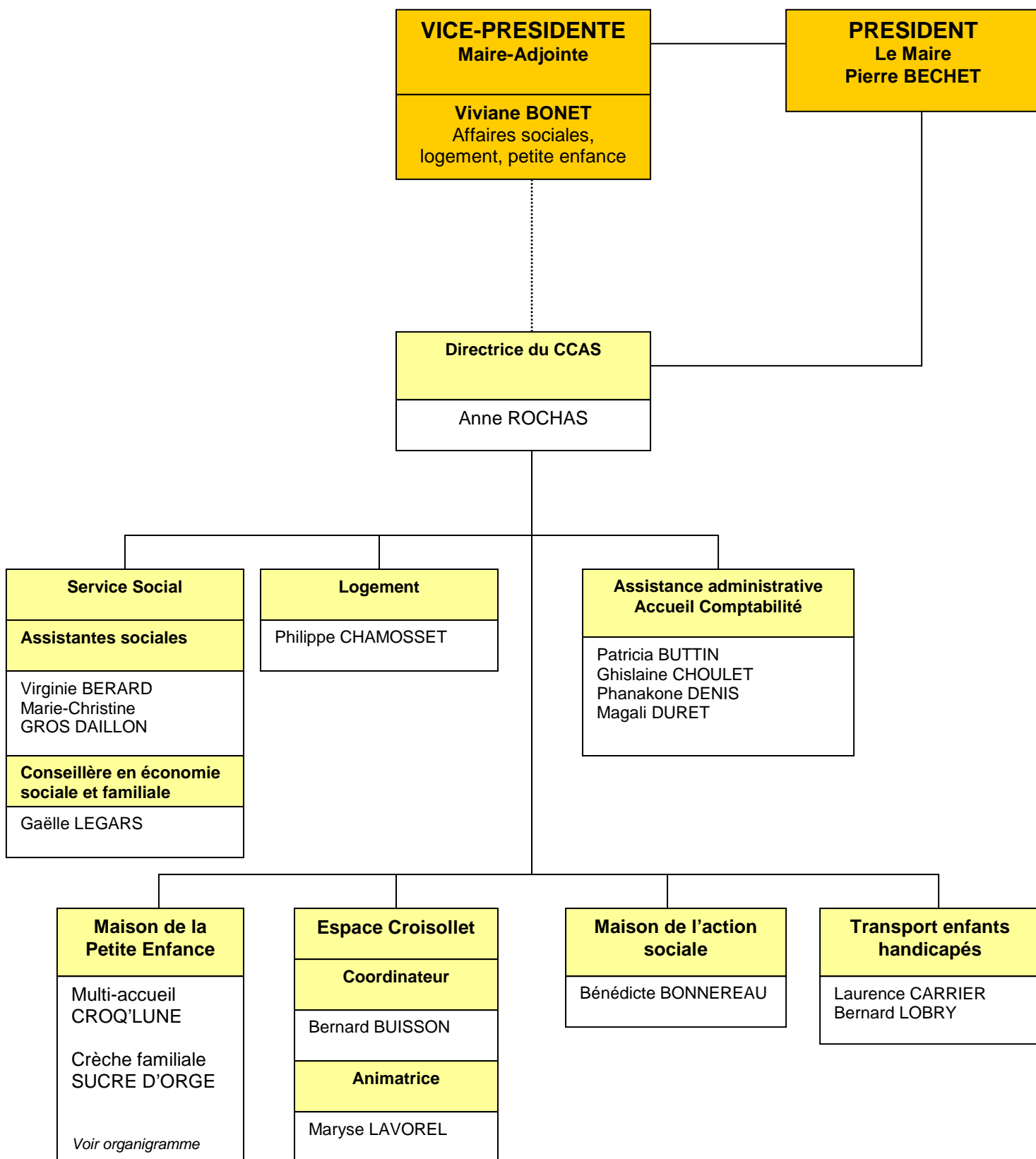

MAISON DE LA PETITE ENFANCE

CENTRE COMMUNAL D'ACTION SOCIALE

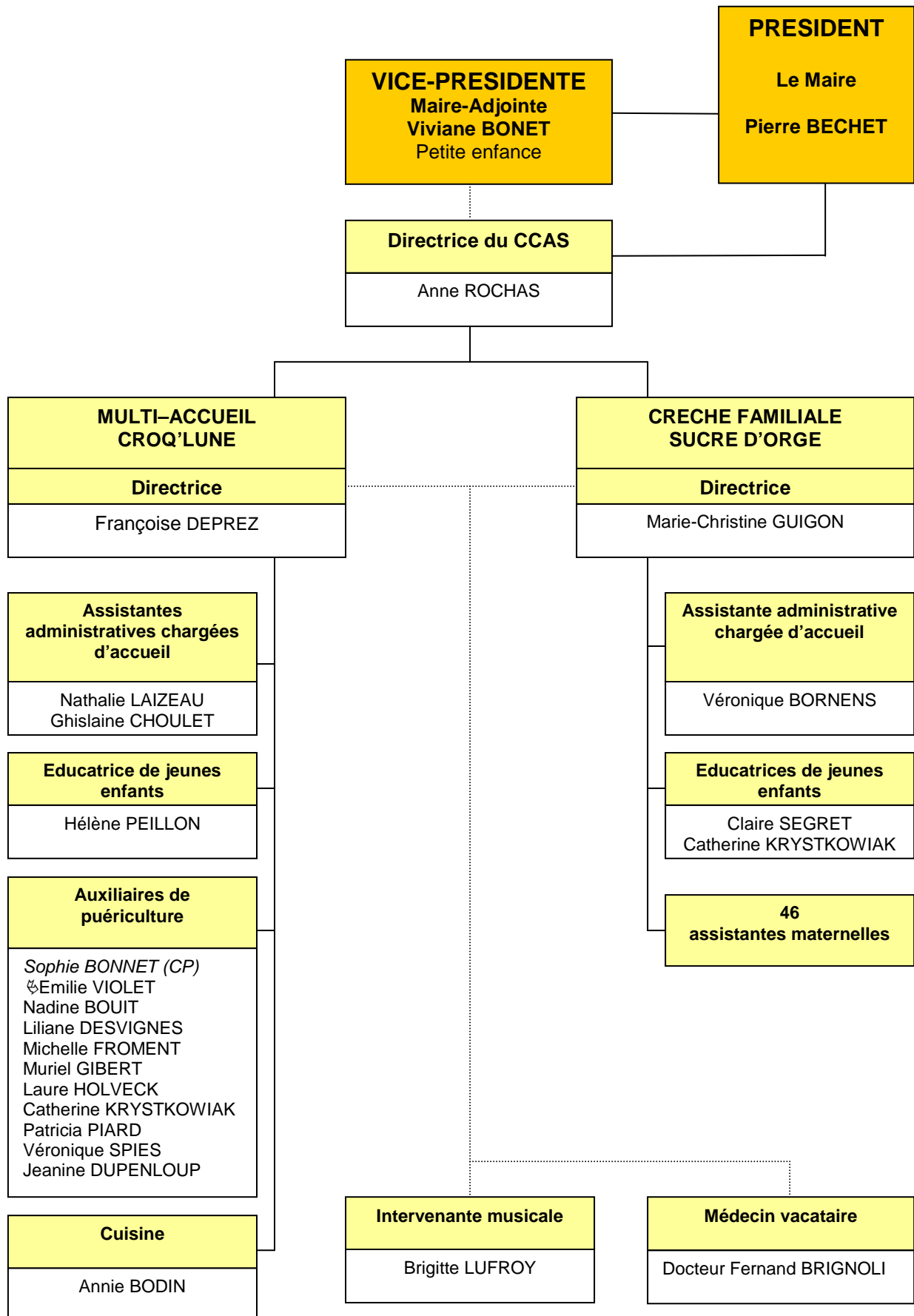

ASSISTANTES MATERNELLES

CENTRE COMMUNAL D'ACTION SOCIALE

